

# COS TIAN ZA



Luceplan. Made in Light

# COS TAN ZA

design  
Paolo Rizzato

table / floor / wall / suspension



Video  
<http://vimeo.com/40516149>

One of the iconic lamps of contemporary Italian design, since 1986 Costanza has been a true Luceplan bestseller. Its success can be attributed first of all to the contemporary reinterpretation of the traditional “abat-jour” typology. Over time Costanza has evolved and developed, generating a large family of lamps suitable for all lighting needs in any type of space, from the home to contract applications. Its timely image has now been updated with a new range of finishes and colors.

Annoverata tra le lampade icona del design italiano contemporaneo, dal 1986 Costanza si conferma bestseller di Luceplan. Il suo successo è da attribuire innanzitutto alla rivisitazione in chiave contemporanea della tradizionale tipologia dell'abat-jour. Nel tempo, Costanza si è evoluta e sviluppata, dando vita ad una grande famiglia di lampade adatte ad ogni esigenza d'illuminazione. L'attualità di Costanza si riverbera nella rinnovata gamma di finiture e colori in cui è disponibile.

Costanza zählt zu den Ikonen modernen italienischen Leuchtendesigns und ist seit 1986 ein Luceplan-Bestseller. Ihr Erfolg gründet in erster Linie in der modernen Interpretation der traditionellen Stehlampenversion. Im Laufe der Zeit hat sich Costanza weiterentwickelt und zum Entstehen einer großen Leuchtenfamilie geführt, die allen Beleuchtungsanforderungen gerecht wird und sich für jedes Ambiente, vom Wohnbereich bis hin zum Contract-Bereich, eignet. Eine mit den neuen Farben und Ausführungen, in denen sie jetzt erhältlich ist, nach wie vor höchst aktuelle Leuchte.

Comptant parmi les lampes icônes du design italien contemporain, depuis 1986, Costanza se confirme comme bestseller de Luceplan. Son succès est en grande partie dû à la réinterprétation de manière contemporaine de la typologie traditionnelle de l'abat-jour. Au fil de temps, Costanza a évolué et s'est développée, créant ainsi une grande famille de lampes adaptées à tous les besoins d'éclairage et à tout type d'espace, de la maison au contract. Son actualité se reflète dans sa gamme renouvelée de finitions et de couleurs disponibles.

Costanza, una de las lámparas icono del diseño italiano contemporáneo, se ha consolidado como best seller de Luceplan desde 1986. Su éxito se debe sobre todo a la recuperación en clave contemporánea de la tipología tradicional de la tulipa. Con el tiempo, Costanza ha evolucionado y se ha desarrollado, dando vida a una gran familia de lámparas aptas para cualquier necesidad de iluminación y para cualquier tipo de espacio, desde el hogar hasta la decoración contract. Su actualidad se refleja en la renovada gama de acabados y colores en los que está disponible.



Sofitel, Wien  
Project Jean Nouvel

## MEZZO TONO collection

The Mezzo Tono collection offers a range of pastel shades that are inspired by the paintings of Morandi, misty landscapes, and soft skins. Light tones that stand out for their subtlety, conveying a warm sense of welcome.

La collezione Mezzo Tono è una gamma morbida e pittorica fatta di sfumature pastello che ricordano i quadri di Morandi, le campagne brumose, le pelli soffici. Tonalità lievi che si distinguono per discrezione e accolgono con calore.

Die Kollektion Mezzo Tono ist eine weiche, malerische Farbpalette mit Pastelltönen. Sie ruft Assoziationen mit den Bildern von Morandi, mit Nebellandschaften die an weiche Felle erinnern hervor. Zarte, zurückhaltende, warme Töne.

La collection Mezzo Tono est une gamme douce et picturale, caractérisée par des nuances pastels qui rappellent les tableaux de Morandi, les campagnes brumeuses, les cuirs souples. Des tonalités légères qui se distinguent par leur discrétion et vous accueillent avec chaleur.

La colección Mezzo Tono es una gama suave y pictórica a base de matices pastel que recuerdan los cuadros de Morandi, los campos brumosos, las pieles suaves. Tonos tenues que se distinguen por su discreción y acogen con calidez.

Comfort green  
Verde alchimia  
Seegrün  
Vert d'eau  
Verde agua



Edgy Pink  
Rosa Mistico  
Mystisches Rosa  
Pêche  
Melocotón



Mistic white  
Bianco Nebbia  
Nebelweiss  
Blanc mystique  
Blanco místico



Soft skin  
Cipria  
Puder  
Rose pâle  
Rosa pálido



Shaded Stone  
Nocciola  
Nougat  
Noisette  
Canela



## RADIEUSE collection

The Radieuse collection is made of decisive and dynamic colors with the same tones seen in the architecture and paintings of the modern masters. The original hues have been adjusted with slight tonal variations, making them more versatile and vibrant.

La collezione Radieuse è fatta di colori decisi e dinamici che irradiano dalle architetture e dalla pittura dei maestri moderni. I colori originari delle prime Costanza sono attraversati da lievi sottrazioni tonali, che li rendono duttili e vibranti.

Die Kollektion Radieuse entstand: Kräftige, dynamische Farben, die den reinen Tönen der ersten Costanza Modernität verleihen, die gleichen Farben, die von der Architektur und der Malerei zeitgenössischer Meister ausgehen. Die leichten Änderungen geben den ursprünglichen Farben Geschmeidigkeit und pulsierende Leuchtkraft.

La collection Radieuse est faite des couleurs fortes et dynamiques qui irradient des architectures et des tableaux des grands Maîtres modernes. Les couleurs originales sont traversées de légères soustractions tonales qui les rendent souples et vibrantes.

La colección Radieuse se compone de colores decididos y dinámicos que irradian de las arquitecturas y la pintura de los maestros modernos. Los colores originales están caracterizados por tenues sustracciones tonales que hacen que sean dúctiles y vibrantes.

Primary red  
Rosso primario  
Johannisbeerrot  
Rouge primaire  
Rojo primario



Concrete grey  
Grigio cemento  
Betongrau  
Gris béton  
Gris asfalto



Petroleum blue  
Blu petrolio  
Petrolblau  
Bleu marine  
Azul petroleo



Liquorice black  
Nero liquirizia  
Lakritzschwarz  
Noir réglisse  
Negro hollin



Smart yellow  
Giallo vivo  
Kanariengelb  
Jaune vif  
Amarillo fuerte





Video  
[vimeo.com/40000132](https://vimeo.com/40000132)



## table

Blending tradition and technology, Costanza reinterprets the classic repertoire with contemporary forms. The interchangeable polycarbonate lampshade emits a warm and pleasant light. The rod-like sensor dimmer switch turns the lamp on and off, with four light intensities.

1986

h 80 cm, 76/100 cm  
 base 18x18 cm, shade Ø 40 cm

aluminium body  
 alu, black, off white

interchangeable polycarbonate  
 silkscreened shade  
 white, Mezzo Tono collection  
 and Radieuse collection  
 (see page 66-68)

max 150W E27,  
 105/140W halogen energy saver

Coniugando tradizione e tecnologia, Costanza declina il classico in forma contemporanea. Il paralume intercambiabile di polycarbonato diffonde una luce calda e gradevole. Il dimmer sensoriale ad astina permette di regolare l'accensione e lo spegnimento passando per quattro livelli di intensità luminosa.

In einer Kombination aus Tradition und Technologie Costanza ist eine klassische Leuchte in zeitgenössischer Form. Der auswechselbare Lampenschirm aus Polycarbonat verbreitet ein warmes, angenehmes Licht. Der Sensordimmer mit Stäbchen schaltet über vier Lichtintensitätsstufen die Leuchte ein und aus.

Alliant tradition et technologie, Costanza décline le classique sous la forme contemporaine. L'abat-jour interchangeable en polycarbonate diffuse une lumière chaude et agréable. Le variateur sensoriel à tige permet de régler l'allumage et l'extinction en passant par quatre niveaux d'intensité lumineuse.

Conjugando tradición y tecnología, Costanza declina el clásico hacia la forma contemporánea. La pantalla intercambiabile de polycarbonato difunde una luz cálida y agradable. El dimmer sensorial de varilla permite regular el encendido y el apagado, pasando por cuatro niveles de intensidad luminosa.



## floor

Ethereal and uncluttered, this lamp fits naturally into any setting. Costanza is an archetypal example of modern, colourful elegance. The polycarbonate diffuser rests on the aluminium structure at two points alone.

1986

h 153 cm, 120/160 cm  
base 18x18 cm, shade Ø 40 cm

aluminium body  
alu, black, off white

interchangeable polycarbonate  
silkscreened shade  
white, Mezzo Tono collection  
and Radieuse collection  
(see page 66-68)

max 150W E27,  
105/140W halogen energy saver

Eteera ed essenziale si  
inserisce con naturalezza  
in qualsiasi contesto.  
Costanza è l'archetipo  
dell'eleganza moderna.  
Il diffusore in policarbonato  
è sostenuto dalla struttura  
in alluminio su due soli  
punti di appoggio.

Ätherisch und essentiell.  
Fügt sich mit Natürlichkeit  
in jeden Kontext ein.  
Costanza ist das Urbild  
moderner Eleganz.  
Der Diffusor aus  
Polykarbonat wird durch die  
Aluminiumstruktur an nur  
zwei Haltepunkten gestützt.

Elégante et intemporelle,  
elle s'insère très  
naturellement dans tous les  
environnements.  
Costanza est l'archétype  
en couleur de l'élégance  
moderne.  
Le diffuseur en  
polycarbonate est soutenu  
par la structure en  
aluminium sur deux seuls  
points d'appui.

Etérea y esencial se integra  
naturalmente en cualquier  
ambiente.  
Costanza es el arquetipo  
coloreado de la elegancia  
moderna.  
El difusor de policarbonato  
está sostenido por la  
estructura de aluminio en  
sólo dos puntos de apoyo.





## wall

Slender and discrete, this lamp fits easily into any room, whether public or private.

The lamp is easily turned on and off by means of a rod-switch placed next to the source of light.

1986

h 80 or 76/100 cm  
shade Ø 40 cm

aluminium body  
alu, off white

interchangeable polycarbonate  
silkscreened shade  
white, Mezzo Tono collection  
and Radieuse collection  
(see page 66-68)

max 150W E27,  
105/140W halogen energy saver

Esile e discreta si inserisce con semplicità in qualsiasi contesto, pubblico o privato. L'interruttore ad astina luminosa permette di regolare comodamente l'accensione e lo spegnimento.

Zart und diskret fügt sie sich mit Leichtigkeit in jeden öffentlichen oder privaten Kontext ein. Der Stäbchen-Schalter an der Lampenfassung erleichtert das Ein- und Ausschalten.

Fine et discrète, elle s'insère en toute simplicité dans tous les environnements, publics ou privés. L'interrupteur à tige situé près de la source lumineuse permet de régler de manière aisée l'allumage et l'extinction.

Grácil y discreta se integra con sencillez en cualquier ambiente, público o privado. El interruptor de varilla ubicado cerca de la fuente lumínica permite regular cómodamente el encendido y el apagado.





## suspension

Elegant and light, this lamp emits a pleasant warm light through a silk-screened polycarbonate shade. The lamp's height may be adjusted by means of a characteristic stainless steel counterweight.

1986

h 100/150 cm or 100/220 cm  
shade Ø 40 cm

aluminium body alu

interchangeable polycarbonate  
silkscreened shade  
white, Mezzo Tono collection  
and Radieuse collection  
(see page 66-68)

max 150W E27,  
105/140W halogen energy saver

Elegante e leggera, diffonde una gradevole luce calda attraverso il paralume in policarbonato serigrafato. L'altezza della versione saliscendi è regolata dal caratteristico contrappeso in acciaio inox.

Elegant und leicht, verbreitet Sie ein angenehm warmes Licht über den Lampenschirm aus siebgedrucktem Polykarbonat. Durch Ziehen am charakteristischen Gegengewicht aus Edelstahl wird bei der Zugleuchte die Pendelhöhe reguliert.

Élégante et légère, elle diffuse une agréable lumière chaude par l'abat-jour en polycarbonate sérigraphié. La hauteur de la version monte et baisse est réglée par le caractéristique contrepoids en acier inox.

Elegante y ligera, difunde una agradable luz cálida a través de la pantalla de serigrafía de policarbonato. La altura de la versión sube-baja está regulada por el característico contrapeso de acero inoxidable.



Costanza suspension lamp allows a very flexible use of the ceiling lamp, because it can be fitted in any part of the ceiling without having to use a light point already fixed.

Costanza sospensione permette un uso molto flessibile della lampada a soffitto perchè è applicabile in qualunque zona del plafone senza bisogno di un punto luce già stabilito.

Die costanza hängeleuchte ist besonders flexibel in der anwendung, da sie unabhängig von einen schon vorgegebenen lichtpunkt angebracht werden kann.

Costanza suspension permet un emploi très flexible de la suspension car elle peut se placer n'importe où sur le plafond sans avoir besoin pour autant d'un point de lumière déjà predisposé.

Costanza suspensión permite un uso muy flexible de la lámpara del techo, ya que puede ser instalado en cualquier parte del techo sin tener que utilizar un punto de luz ya fijada.

D13 COSTANZA

EEI

D13

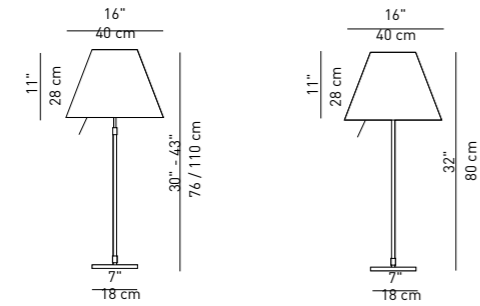

D13 - D13i

D13 i.f.

Lamp D13

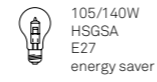

D

Lamp D13 i. - D13 i.f.

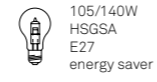

D



A

D13 p.t.

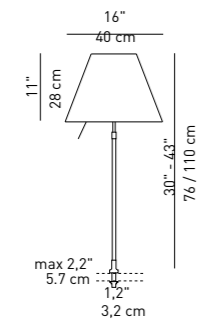

Lamp

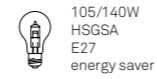

D

D13/90 diffuser accessory

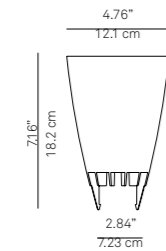

Polycarbonate diffuser for HSGSA E27 Energy saver max 105W bulbs (included). Mounting on the diffuser's rods support.

D13/91 diffuser accessory bulb not included

Materials

aluminium stem interchangeable polycarbonate silkscreened shade

Structure finishes



Shade finishes



Shade finishes Mezzo Tono collection

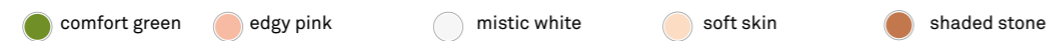

Shade finishes Radieuse collection

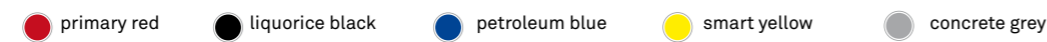

Insulation class



for photometric data see [www.luceplan.com](http://www.luceplan.com)

D13 COSTANZA

EEI

D13 t.  
D13 t.i.  
D13 t.i.f.

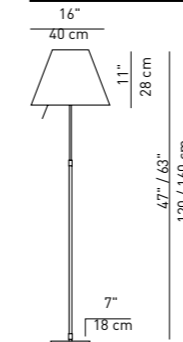

D13 t. - D13 t.i.

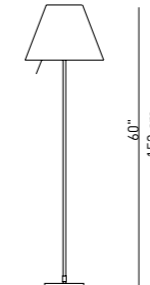

D13 t.i.f.

Lamp D13 t

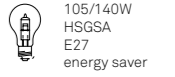

D

Lamp D13 t.i. - D13 t.i.f.

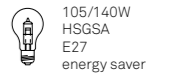

D



A

D13 a.  
D13 a.i.f.  
weight 0,7 Kg

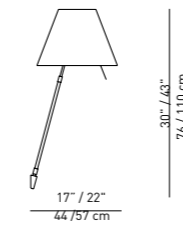

D13 a.

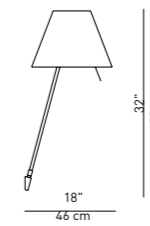

D13 a.i.f.

Lamp D13 a.

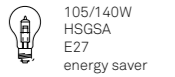

D

Lamp D13 a.i.f.

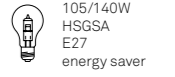

D



A

D13 s.  
D13 sa.s.

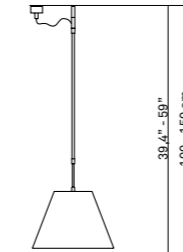

D13 s.  
weight 0,78 kg

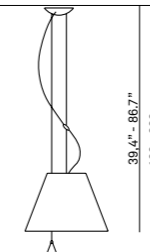

D13 sa.s.  
weight 0,96 Kg

Lamp

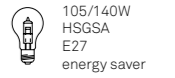

D



A

Materials

aluminium stem interchangeable polycarbonate silkscreened shade

Structure finishes



Shade finishes



Shade finishes Mezzo Tono collection

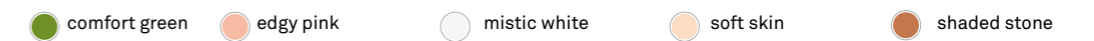

Shade finishes Radieuse collection

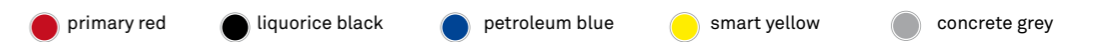

Insulation class



for photometric data see [www.luceplan.com](http://www.luceplan.com)



#### LUCEPLAN HEADQUARTERS

Via E.T. Moneta 40  
20161 Milano  
T +39 02 66 242 1  
F +39 02 66 203 400  
N. verde 800 800 169  
info@luceplan.com

#### LUCEPLAN BELGIUM

Modular Lighting Instruments  
Armoedestraat 71  
8800 Roeselare  
T +32 (0) 51 26 56 56  
F +32 (0) 51 22 80 04  
welcome@supermodular.com

#### LUCEPLAN FRANCE

Modular Lighting Paris  
Rue du Mail, 31  
75002 Paris  
T +33 1 45 42 24 25  
F +33 1 45 42 43 20  
bonjour@supermodular.com

#### LUCEPLAN GERMANY

Prenzlauer Allee 39  
D-10405 Berlin  
T +49 30 44 33 84 0  
F +49 30 44 33 84 22  
luceplan\_de@luceplan.com

#### LUCEPLAN NETHERLANDS

Modular Lighting Nederland  
Bouwerij 54  
1185 XX Amstelveen  
T +31 (0) 20 347 30 47  
F +31 (0) 20 347 30 48  
info@modular.nl

#### LUCEPLAN RUSSIA

Modular Lighting Instruments  
(Representation)  
Mr. Rudy Van Hoof  
Moscow  
T +7 919 991 30 73  
rudy.vanhoof@supermodular.com

#### LUCEPLAN SCANDINAVIA

Klubiensvej 22  
Pakhus 48 - Frihavnen  
DK 2100 Copenhagen  
T +45 36 13 21 00  
F +45 36 13 21 01  
infodk@luceplan.com

#### LUCEPLAN SWEDEN

Ljusgruppen  
Stenyxegatan 17, Box 9134  
20039 Malmö, Sweden  
T +46 40 22 41 00  
www.luceplan.se  
www.ljusgruppen.se

#### LUCEPLAN USA

14 Wooster Street  
New York, NY 10013  
infous@luceplan.com

#### LUCEPLAN SHOWROOM

##### MILANO

Corso Monforte 7  
20122 Milano  
T +39 02 76 015 760  
F +39 02 78 4062  
luceplanstore@luceplan.com

##### NEW YORK

14 Wooster Street  
New York, NY 10013  
Tel. +1 212 966 1399  
Fax +1 212 966 1799  
storeus@luceplan.com

##### COPENHAGEN

Klubiensvej 22  
Pakhus 48 - Frihavnen  
DK-2150 Nordhavn  
T +45 36 13 21 00  
F +45 36 13 21 01  
infodk@luceplan.com

##### OSLO

Nedregata 7  
N-0551 Oslo  
T +47 928 14 481

##### STOCKHOLM

Studio B3  
Barnhusgatan 3  
111 23 Stockholm  
T +46 8 214 231

www.luceplan.com